

**VELUX®**

---

**DSL/RSL**



**CE**



VAS 451508-0908

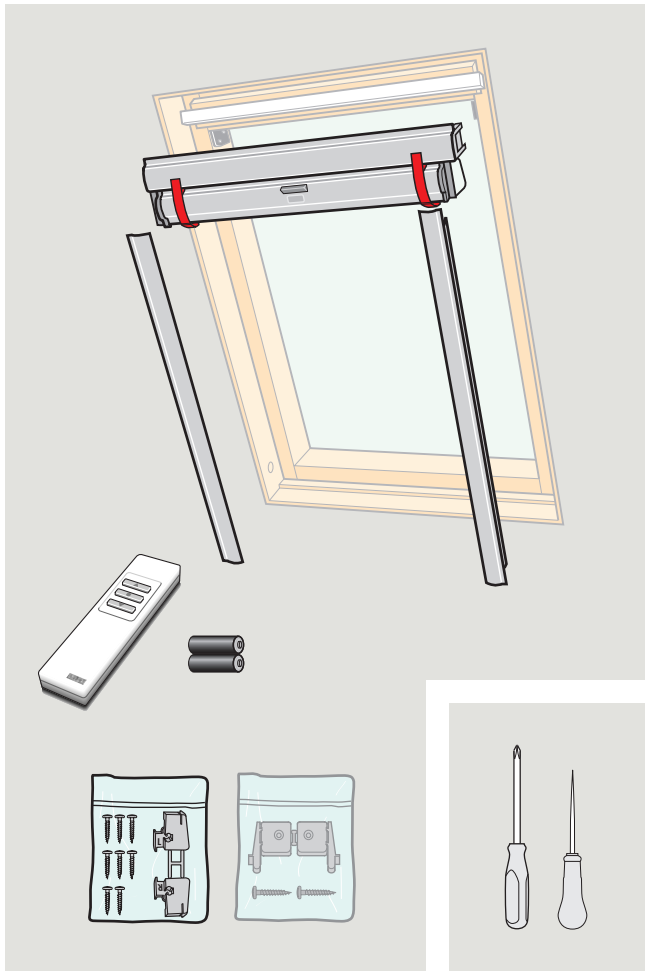

4 VELUX

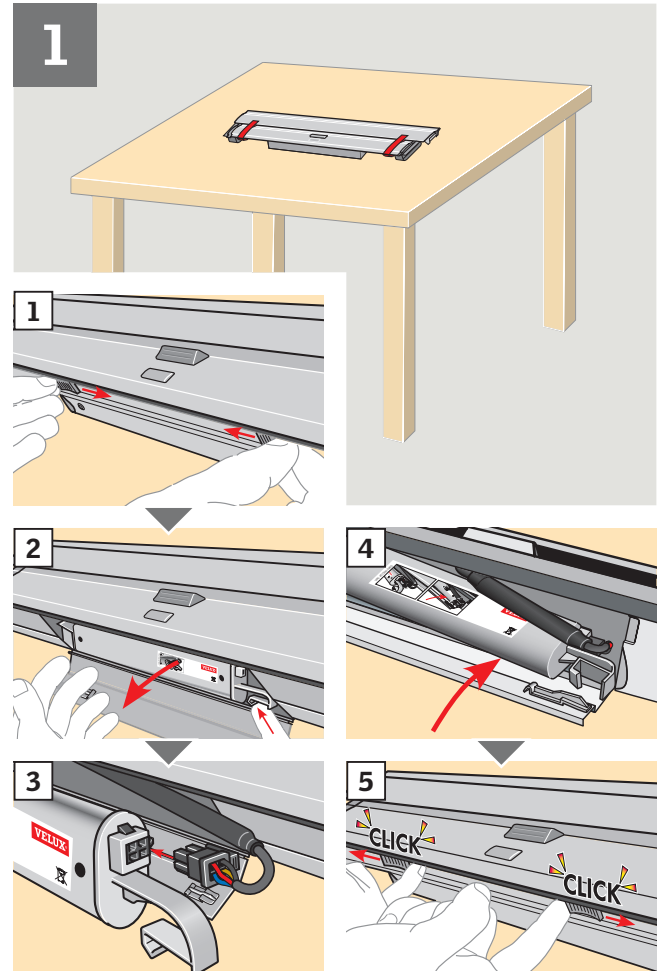

VELUX 5

2

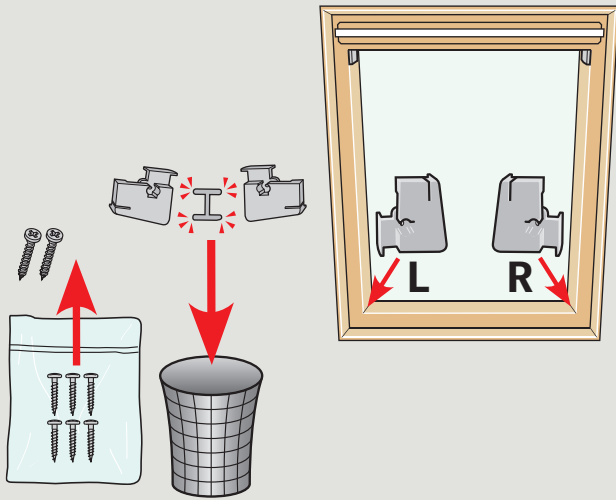

3

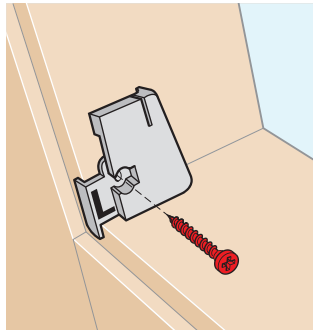
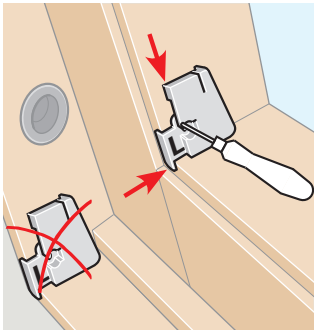

6 VELUX

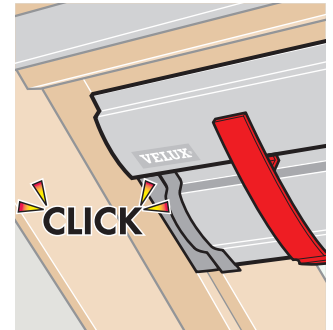
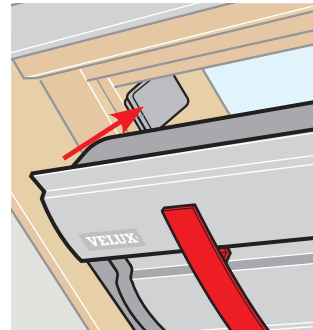

VELUX 7

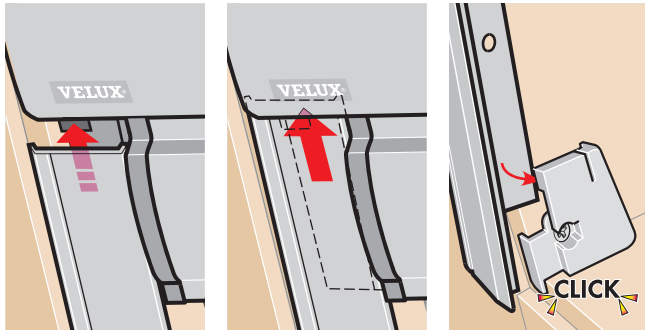
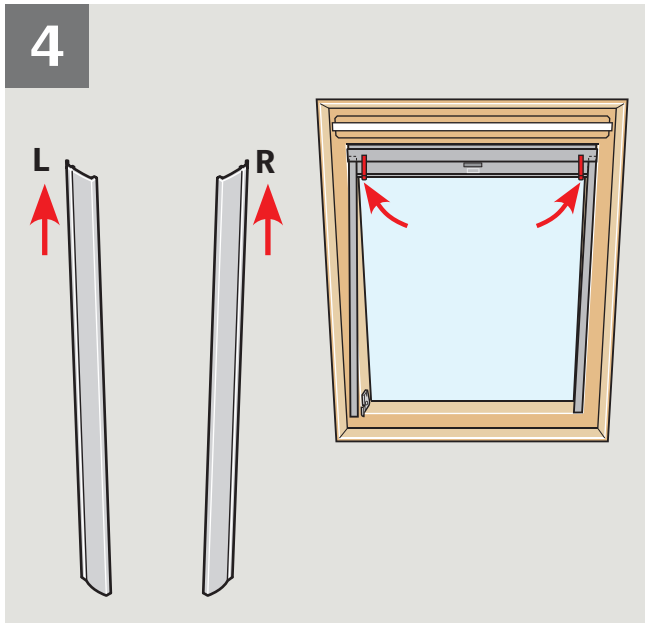

8 VELUX

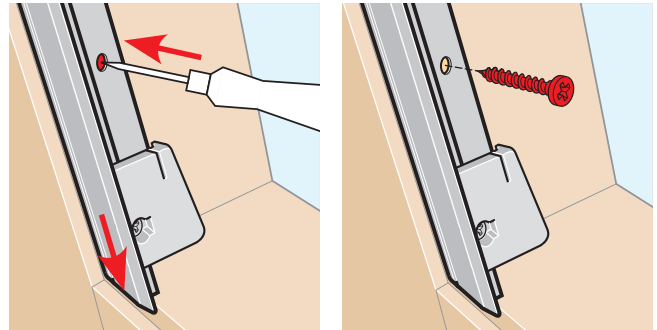
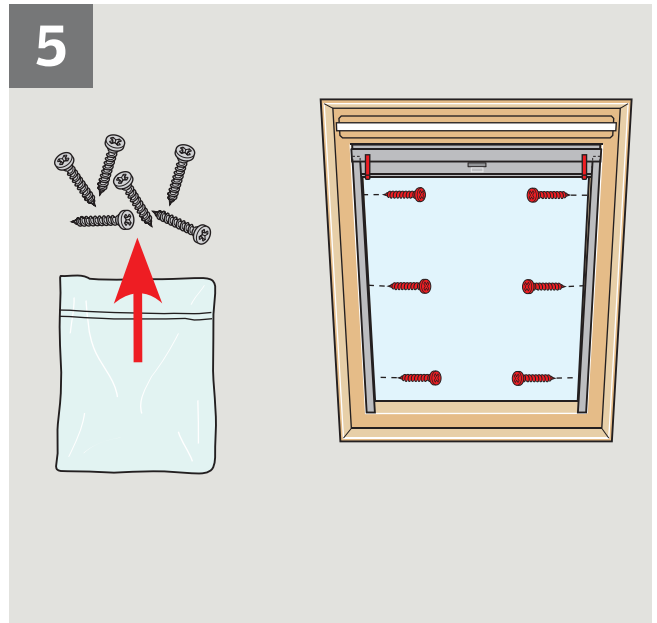

VELUX 9

6

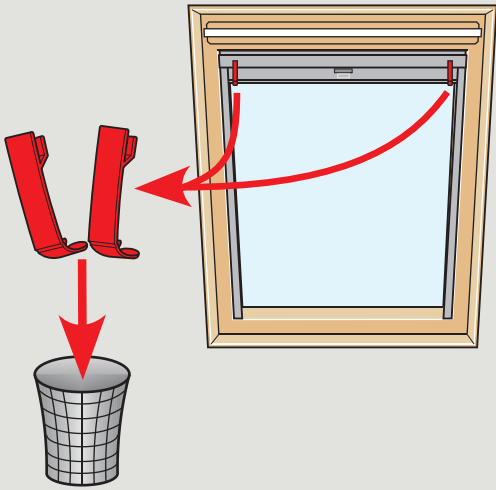

7

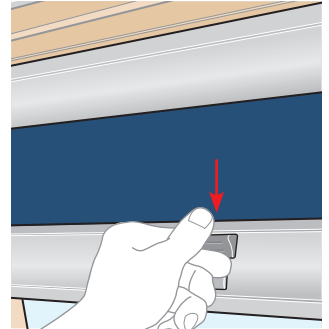
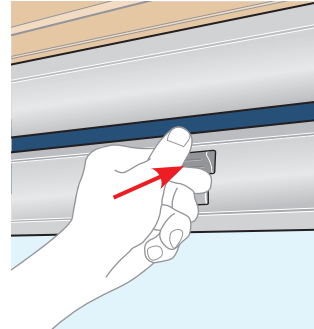
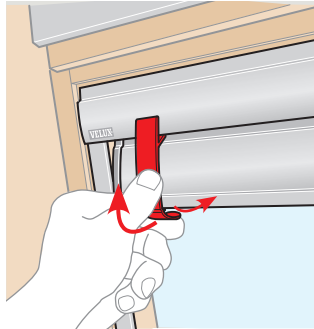
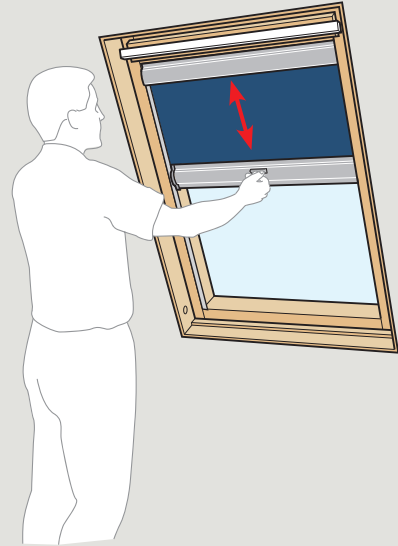

8

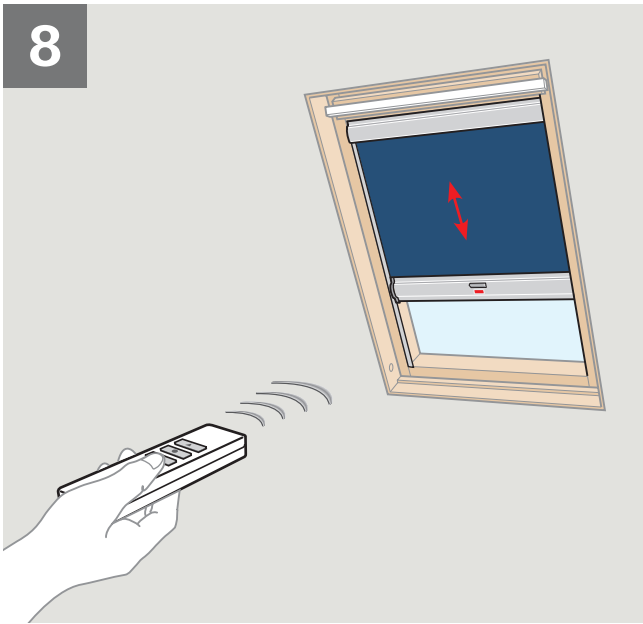

9

