

FHL

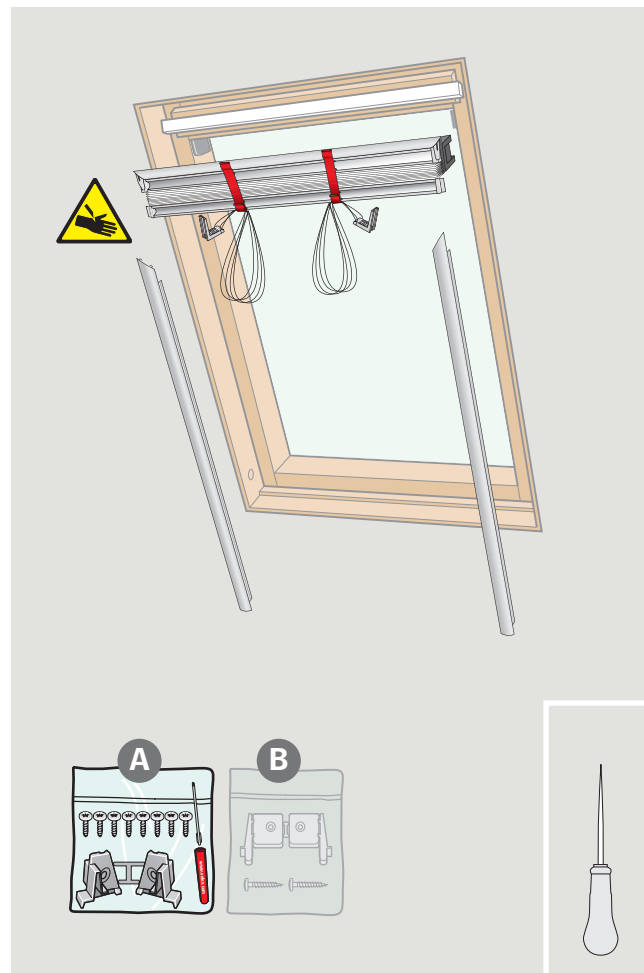

VAS 451911 - 2015-11

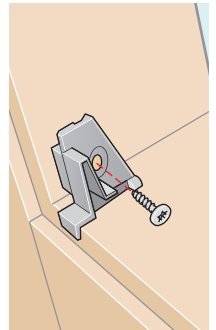
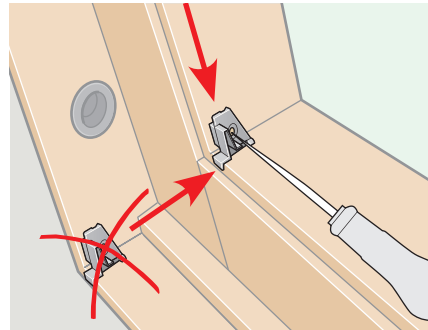
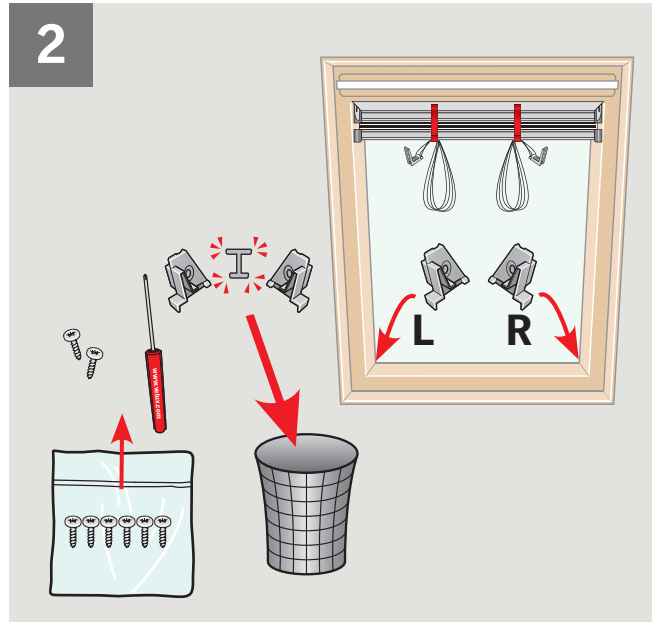
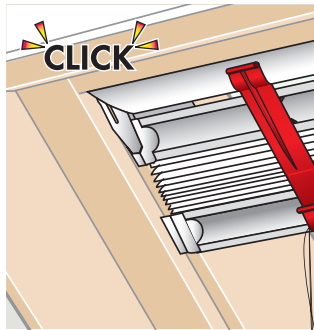
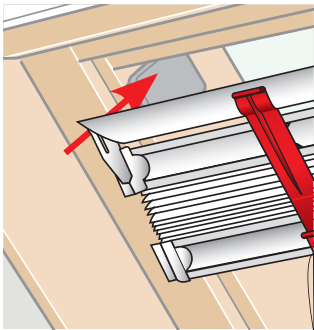
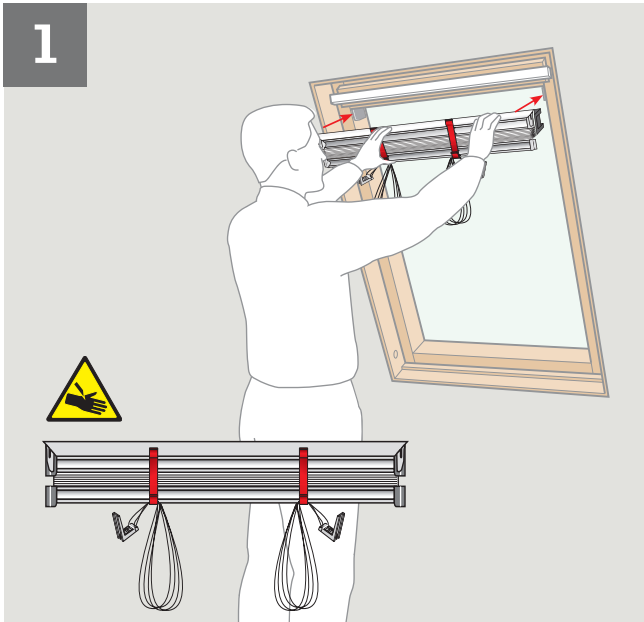

3

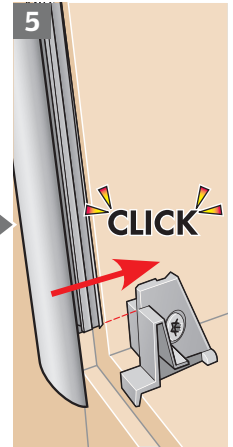
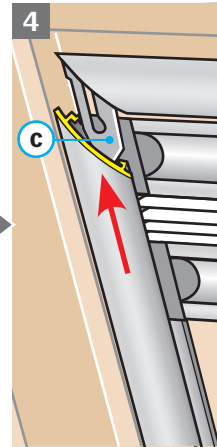
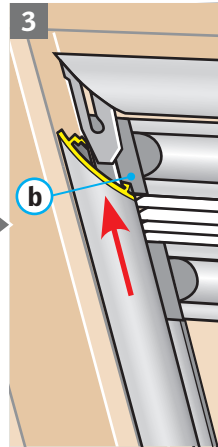
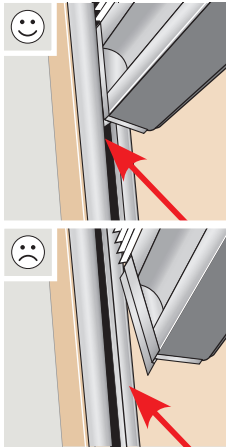
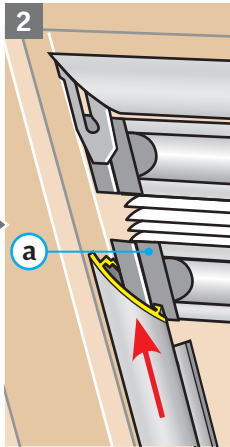
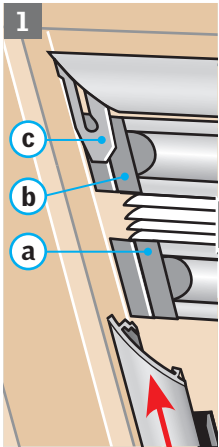
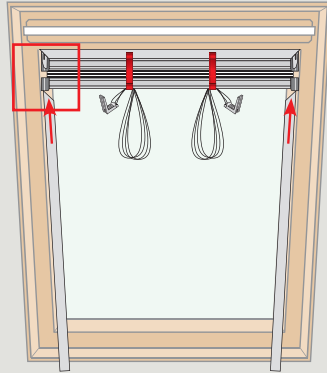
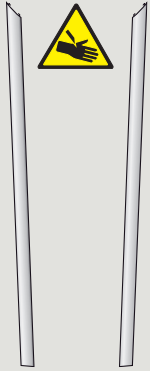

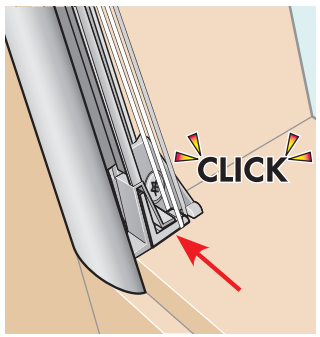
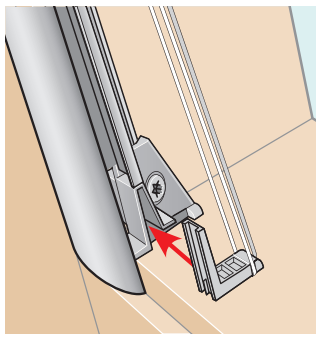
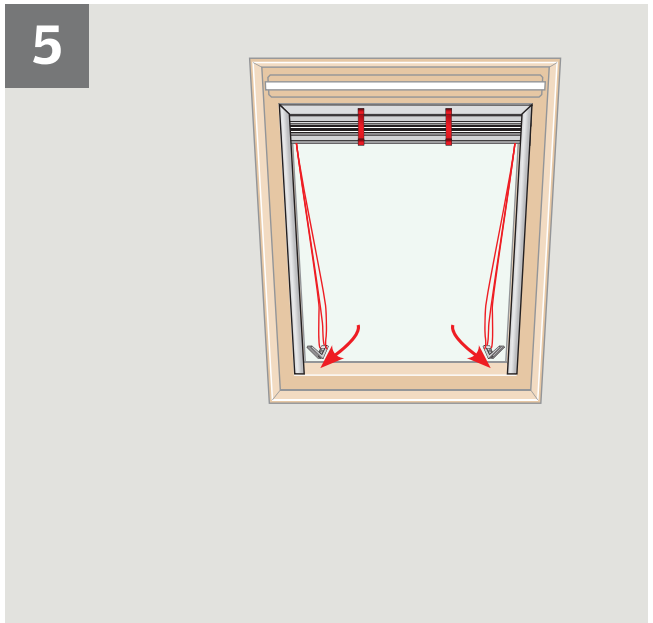
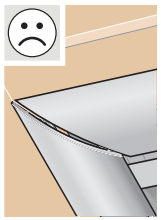
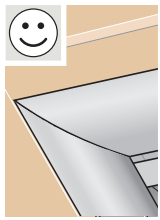
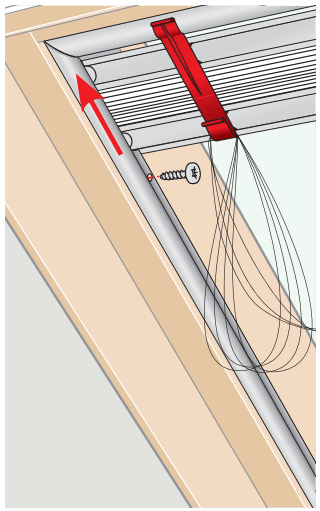
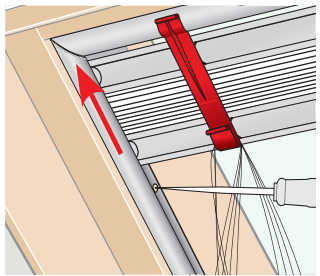
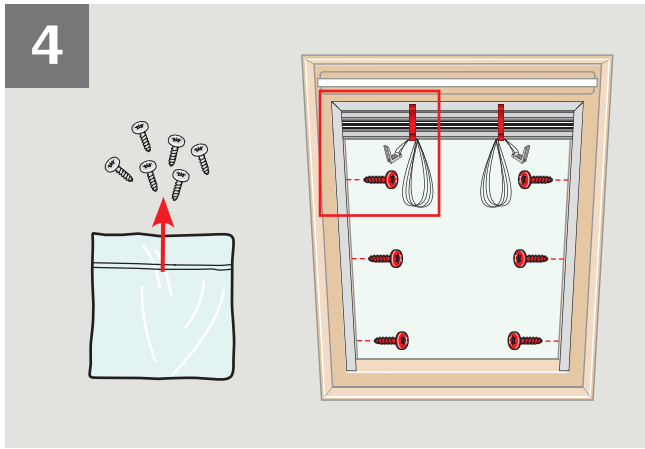

6

